



NICIS
NATIONAL INTEGRATED
CYBERINFRASTRUCTURE SYSTEM

CHPC

DSTI Coding and Robotics

Introduction to the BBC Micro:Bit

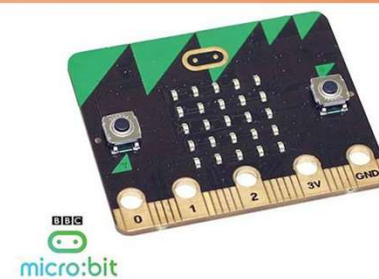



Objectives

- Overview of the Micro:Bit and basics
- Basic commands
- Downloading the programme and running it on device
- Input commands
- Variables
- Conditional selection and more...

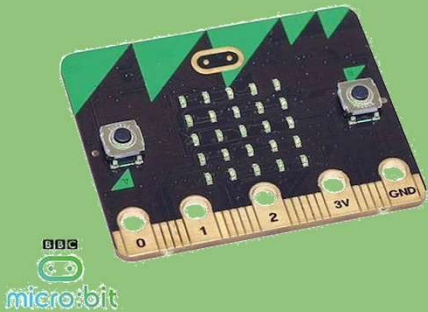

Overview

What is it?

- A pocket-sized codeable computer
- 25 red LEDs that light up, flash messages etc.
- Has two programmable buttons.

Other features

- Can use as a games controller On board motion detector
- Built in compass, temperature sensor and more!
- Bluetooth connectivity

Hand out 😊

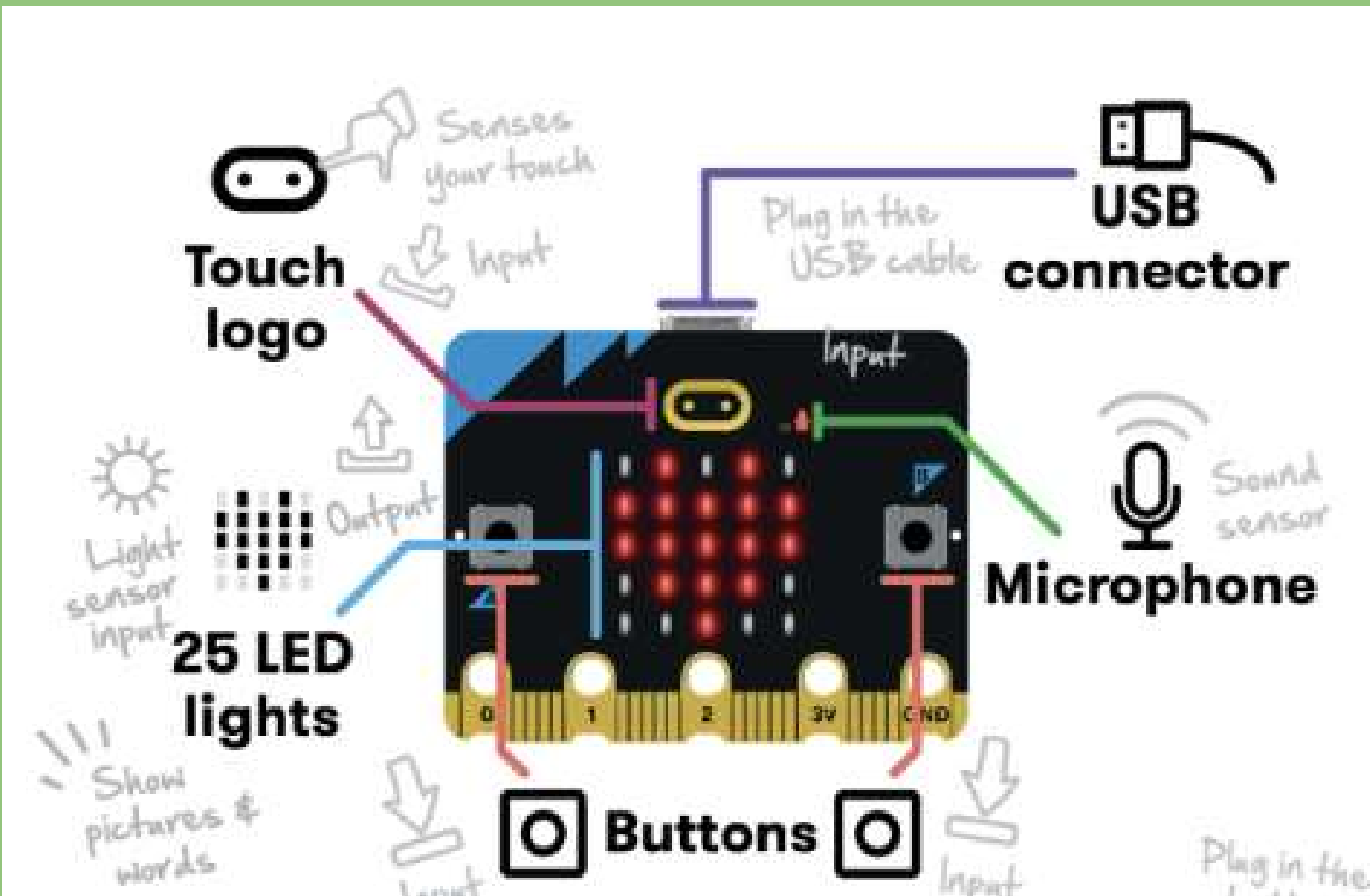

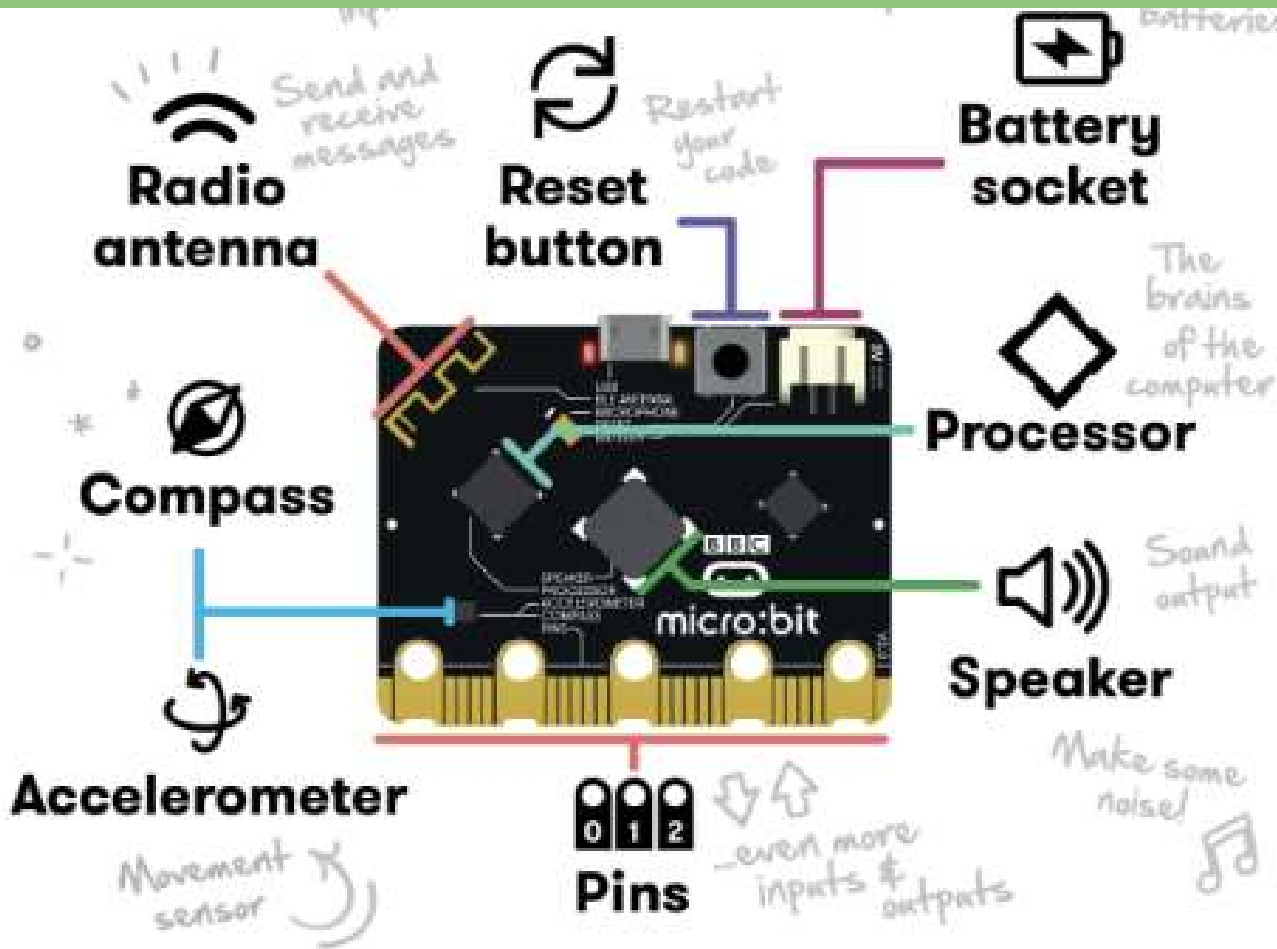

 **micro:bit**

 **NOMINET**
SOCIAL IMPACT

FREE SHIPPING ON ORDERS OVER R1500 🚚



★★★★★ (3)

BBC Micro:Bit Go

R 368.00

Availability: **In Stock**

Brand: micro:bit

coding electronics engineering robotics technology

 **1 - 3 days delivery** with The Courier Guy

 **FREE delivery** on orders over R1500

 **Safe and secure payments** with Stitch

 **Easy returns** with a full refund

Qty:

Use Microsoft Edge or Chrome Browser Only – Easier to programme!

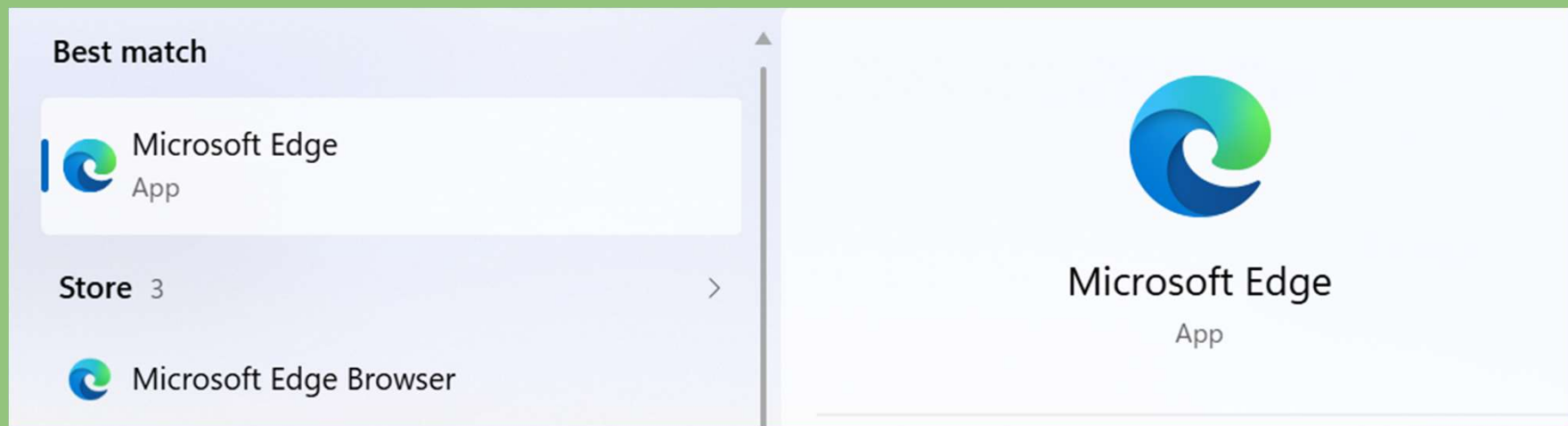

<https://makecode.microbit.org/>

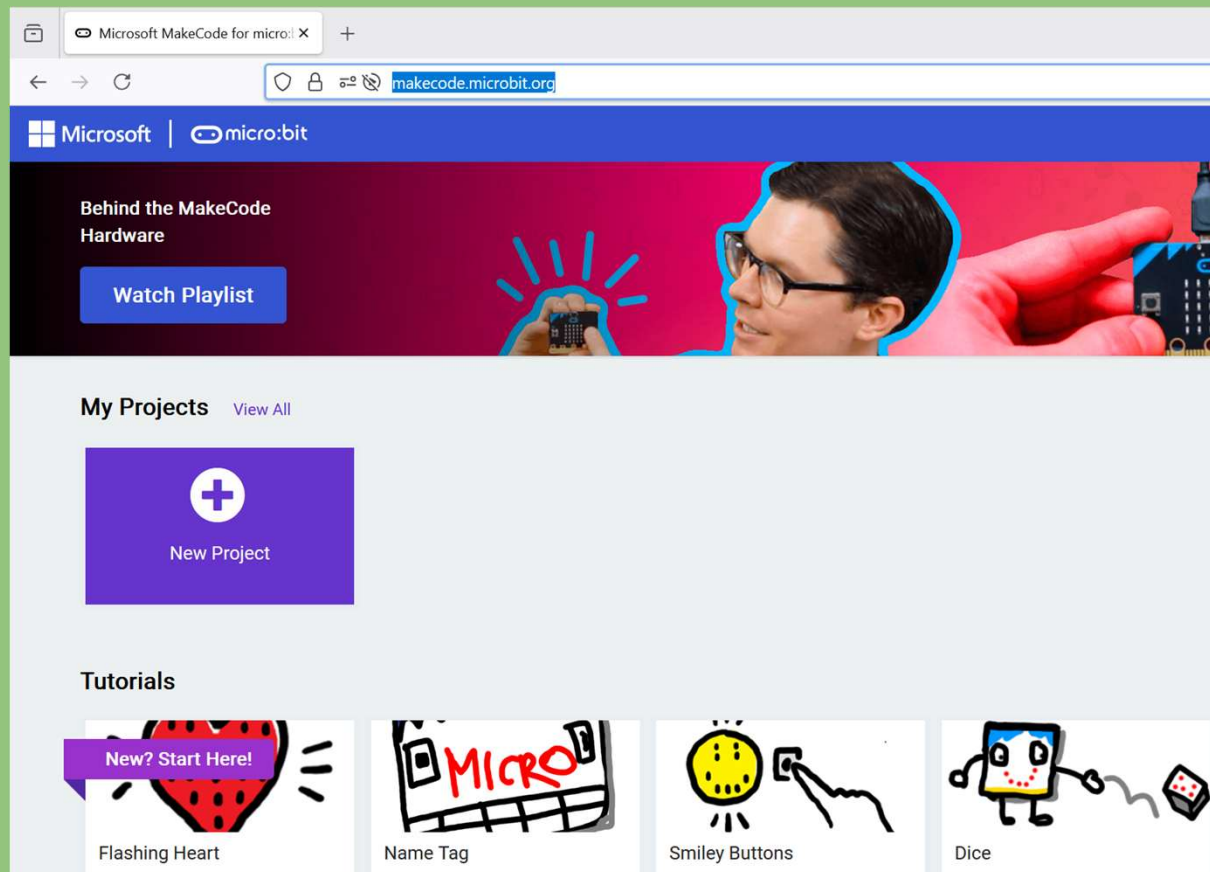

When you plug in your microbit you get this window – ignore!

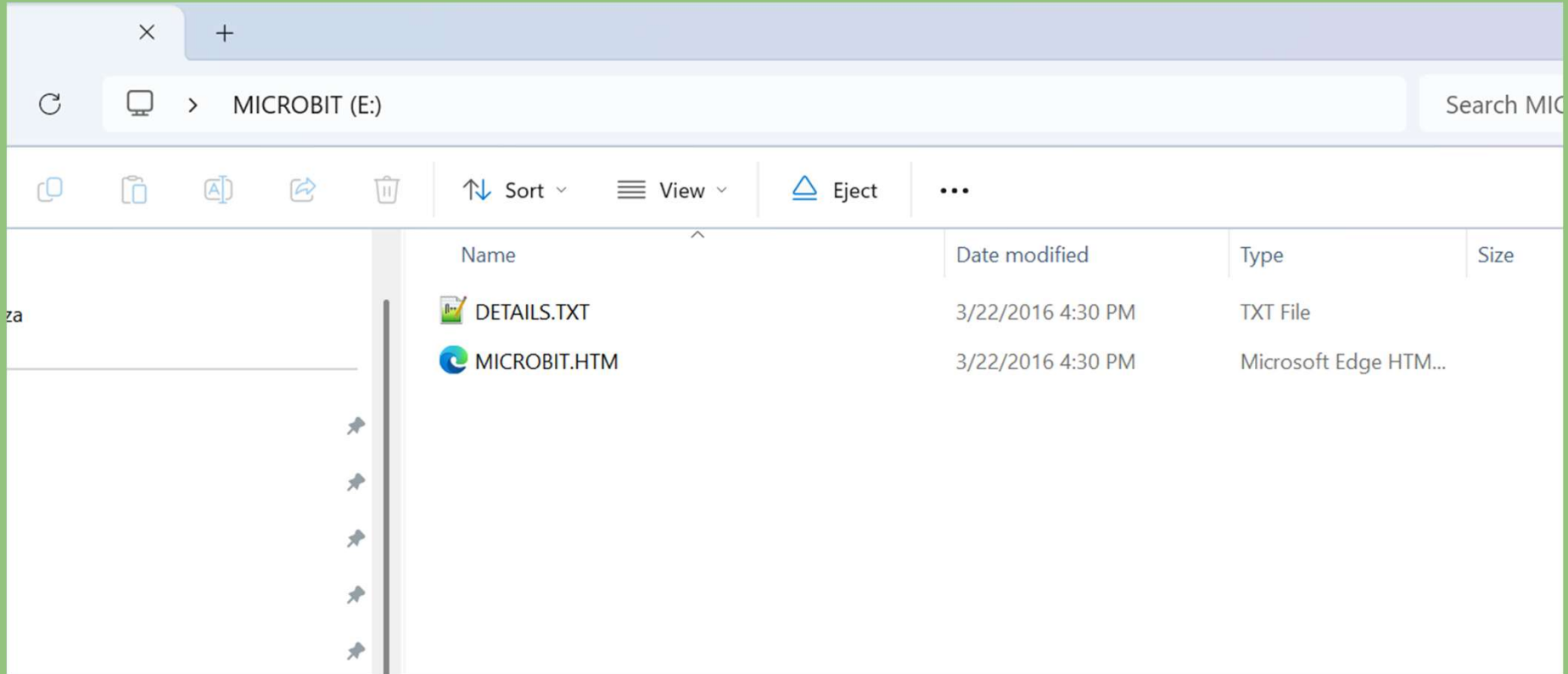



 **micro:bit**

First lessons with MakeCode
and the micro:bit

Lesson 1

Name badge

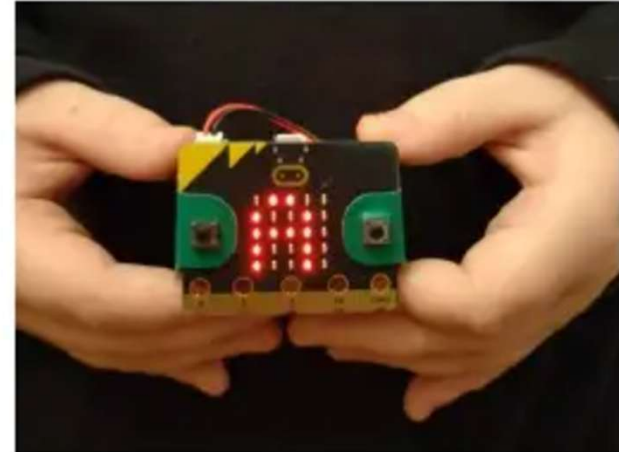



New Project

Create a Project 🥰 🥰



Give your project a name.

[> Code options](#)

Create



Leu

Radio

Welcome!

New here? Take a tour of the editor!

1 of 7

Next

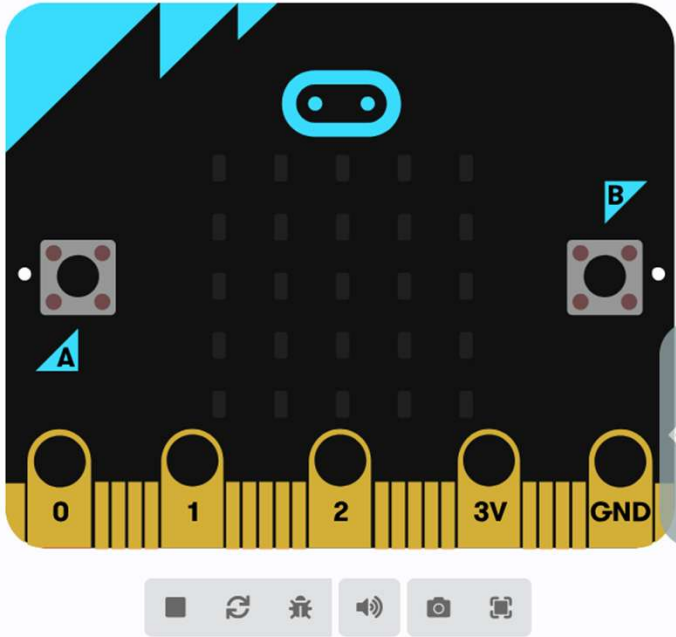

- Search... 🔍
- Basic
 - Input
 - Music
 - Led
 - Radio
 - Loops
 - Logic
 - Variables
 - Math
 - Extensions
 - Advanced

on start forever

A workspace for building a program. It features a light gray grid background. Two blue blocks are placed on the grid: an 'on start' block and a 'forever' loop block. The 'on start' block contains a white key icon, and the 'forever' block also contains a white key icon.

Download

Name Badge

Save Refresh Settings Copy Paste Undo Redo

Introducing the MakeCode editor

- 1 **Toolbox:** find code blocks
- 2 **Workspace:** assemble your code
- 3 **Simulator:** test your code
- 4 **Download** code to your micro:bit

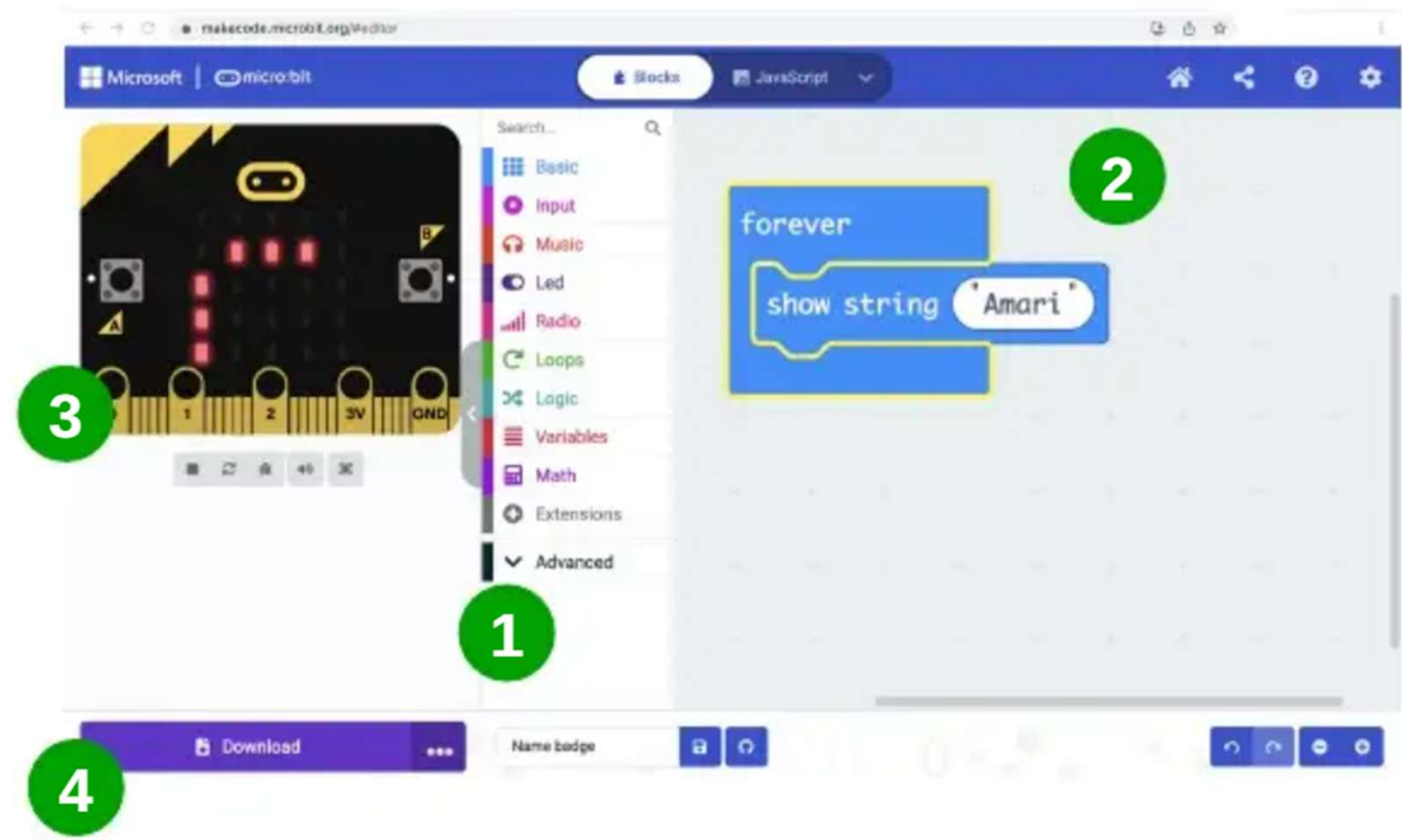

You don't need **on start** so let's drop it back into the toolbox (the middle section) to tidy it away.

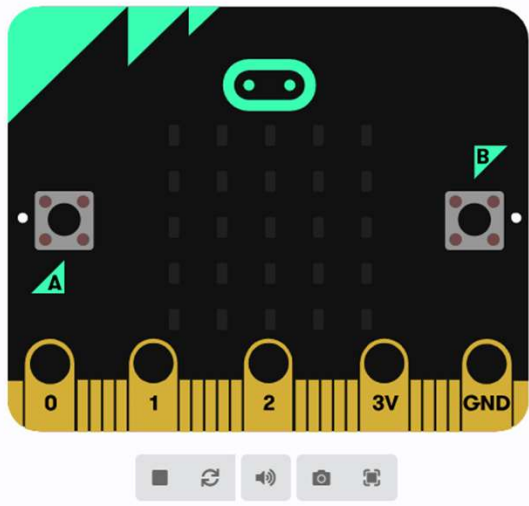

Toolbox

Search...

- Basic
- Input
- Music
- Led
- Radio
- Loops
- Logic
- Variables
- Math



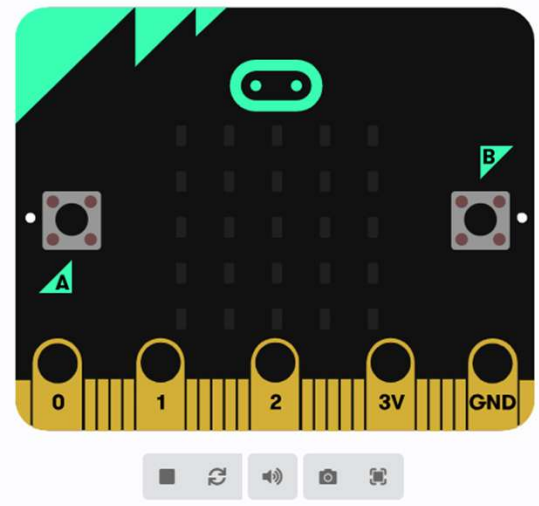

Now find the **show string** block. It's in the Basic category in the toolbox.

Put this inside the **forever** block.

Toolbox categories:

- Basic
- Input
- Music
- Led
- Radio
- Loops
- Logic
- Variables
- Math
- Extensions
- Advanced

Basic category contents:

- show number 0
- show leds
- show icon
- show string "Hello!"

forever loop block

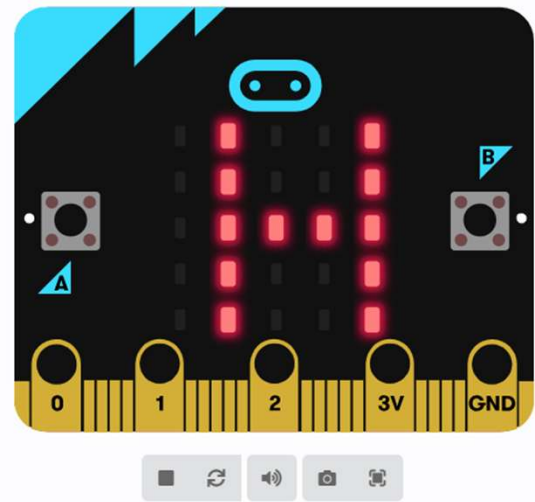

Now find the [show string](#) block. It's in the Basic category in the toolbox.

Put this inside the [forever](#) block.



- Basic
- Input
- Music
- Led
- Radio
- Loops
- Logic
- Variables
- Math
- Extensions
- Advanced

```
forever loop  
  show string "Hello!"
```

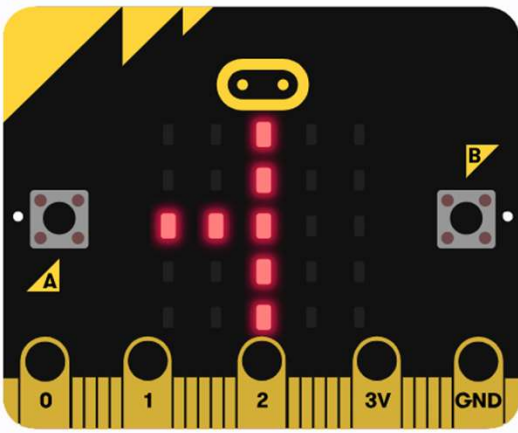

Inside the [show string](#) block, change the text 'hello' to your name.

- Basic
- Input
- Music
- Led
- Radio
- Loops
- Logic
- Variables
- Math
- Extensions
- Advanced

```
forever loop containing a show string block with the text "Hello!"
```

Now download your code onto your micro:bit. Press the download button and follow the instructions.

You should see your name scrolling on your micro:bit.

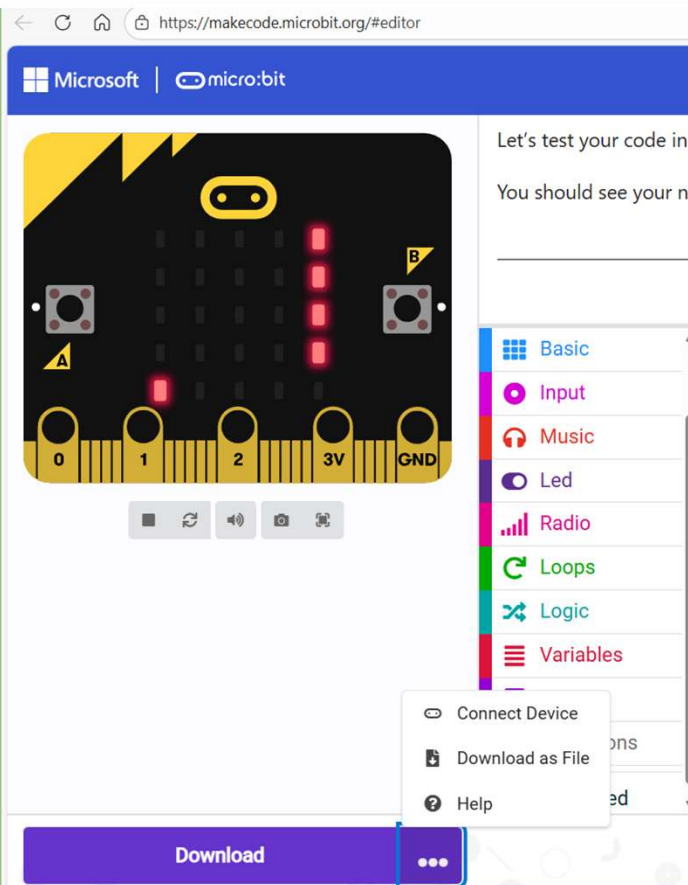

1. Connect your micro:bit to your computer

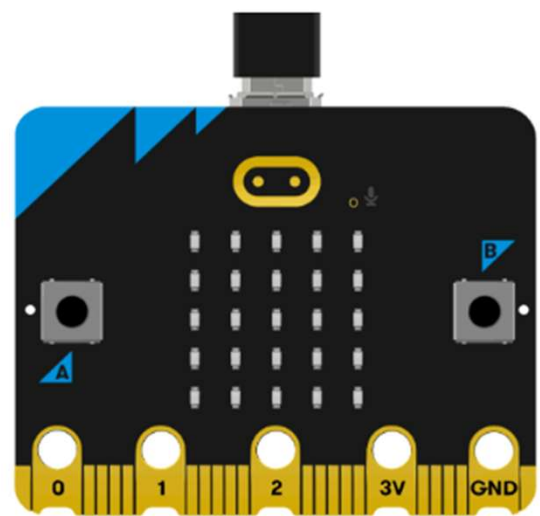

 Next

2. Pair your micro:bit to your browser



Press the Pair button below.

A window will appear in the top of your browser.

Select the micro:bit device and click Connect.

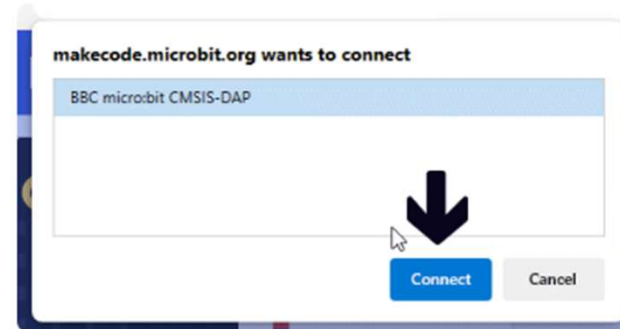

Pair

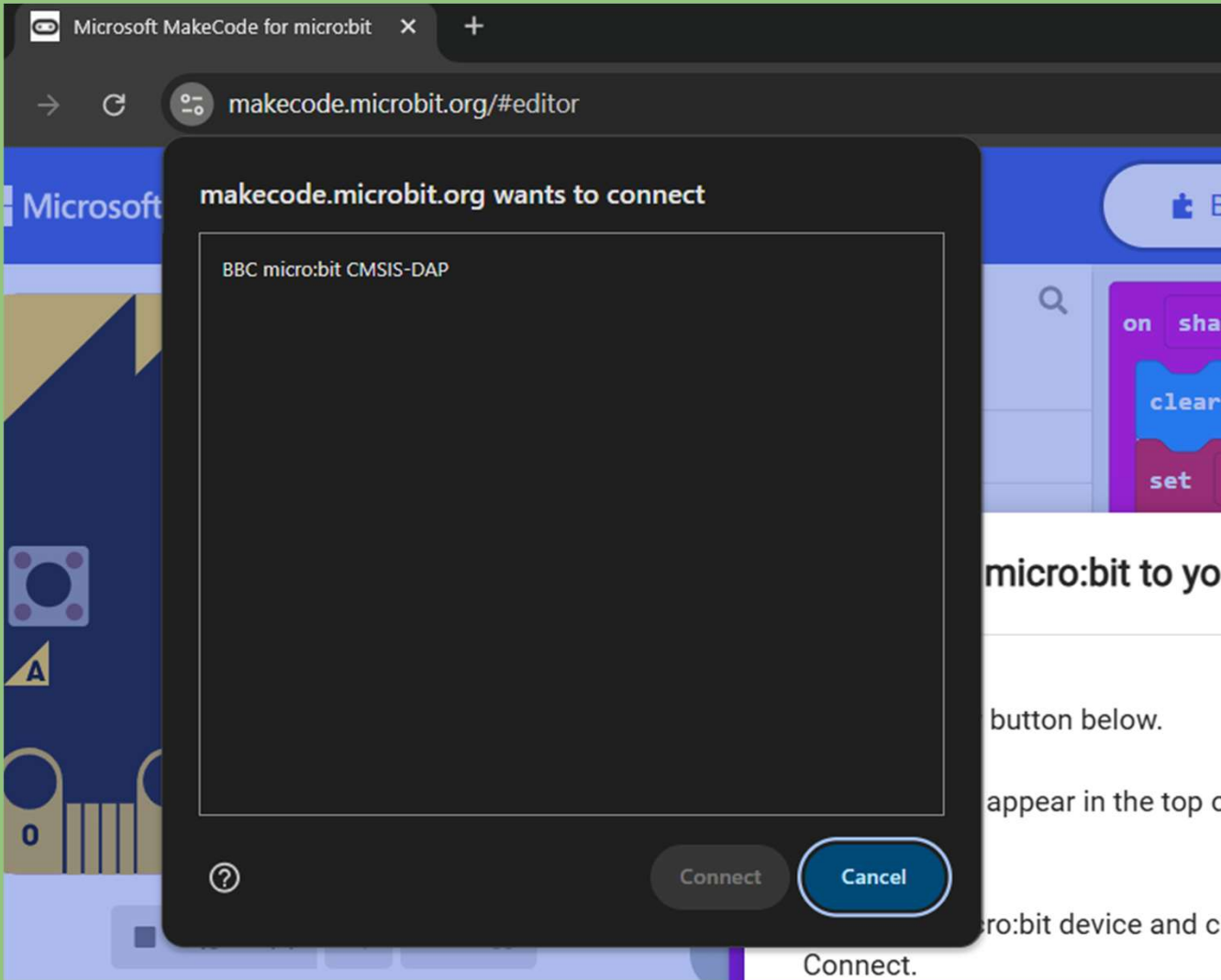

makecode.microbit.org wants to connect

BBC micro:bit CMSIS-DAP



Connect

Cancel

micro:bit to y

button below.

appear in the top

ro:bit device and

Connect.

Input

✓ Connected to micro:bit



Your micro:bit is connected! Pressing 'Download' will now automatically copy your code to your micro:bit.

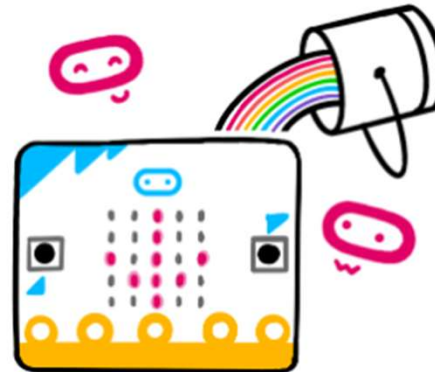

Done

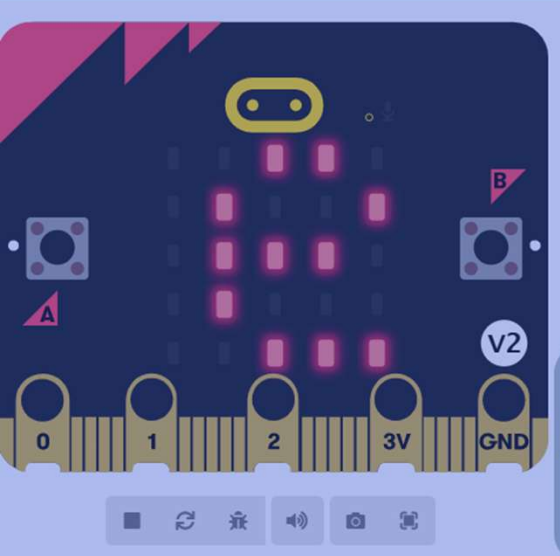

- Search...
- Basic
 - Input
 - Music
 - Led
 - Radio
 - Loops
 - Logic
 - Variables
 - Math
 - Extensions
 - Advanced

A Scratch-style block editor interface. A white Micro:bit icon is centered on a blue grid. Below it, the text "Downloading..." is displayed above a progress bar. To the right, a blue script block is visible, containing a "forever" loop block with a "show string" block inside, displaying the text "Hello!".

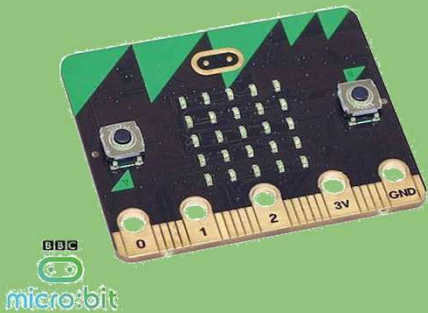

Emulator

Getting to know the Micro:Bit (Basic commands)

Activity 1: Smiley Face

Task: Make a smiling face, then run it on the emulator. What other shapes, pictures can you get it to display?

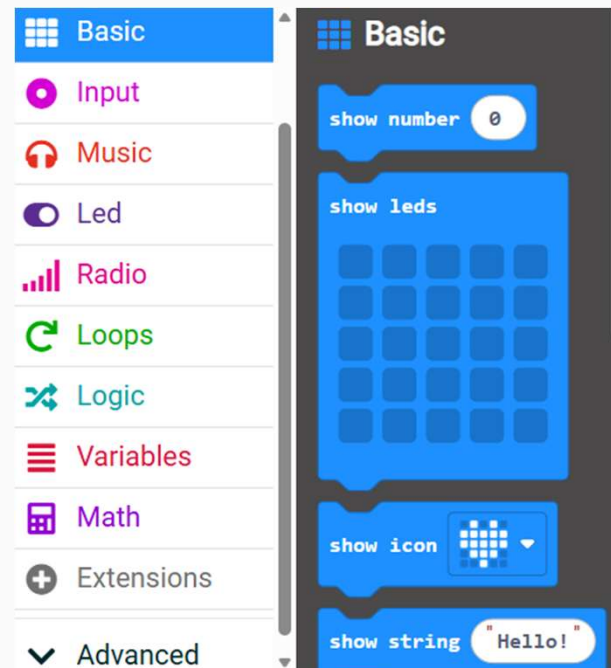

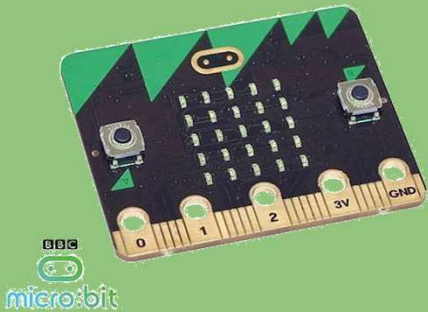

Input Commands

Different ways to run your code

Activity 2: Scrolling name badge

```
on start
  show string "Hello!"
```

Task: Make yourself a scrolling name badge! How about using a different command (e.g. 'on shake').

```
on button A pressed
  show string "First Name"

on button B pressed
  show string "Last Name"

on button A+B pressed
  show string "School Name"
```

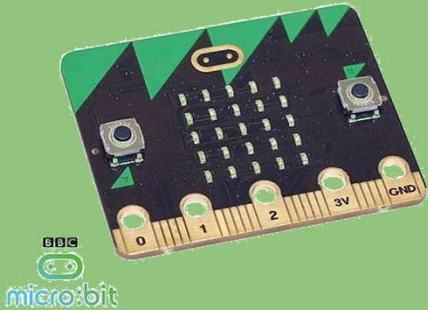

Input Commands

Activity 3: Dice Emulator



Challenge: Can you make the dice pick from 12 numbers? Can you run it based on a different input command?

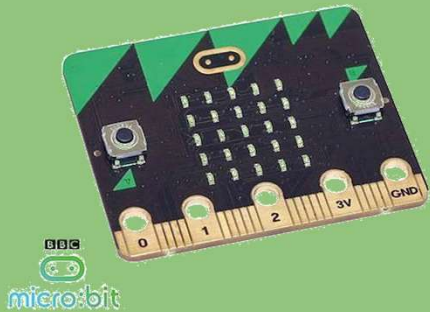

Thermometer Sensor

on button pressed

show number

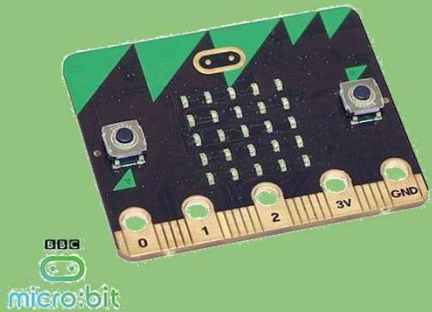

Light Sensor

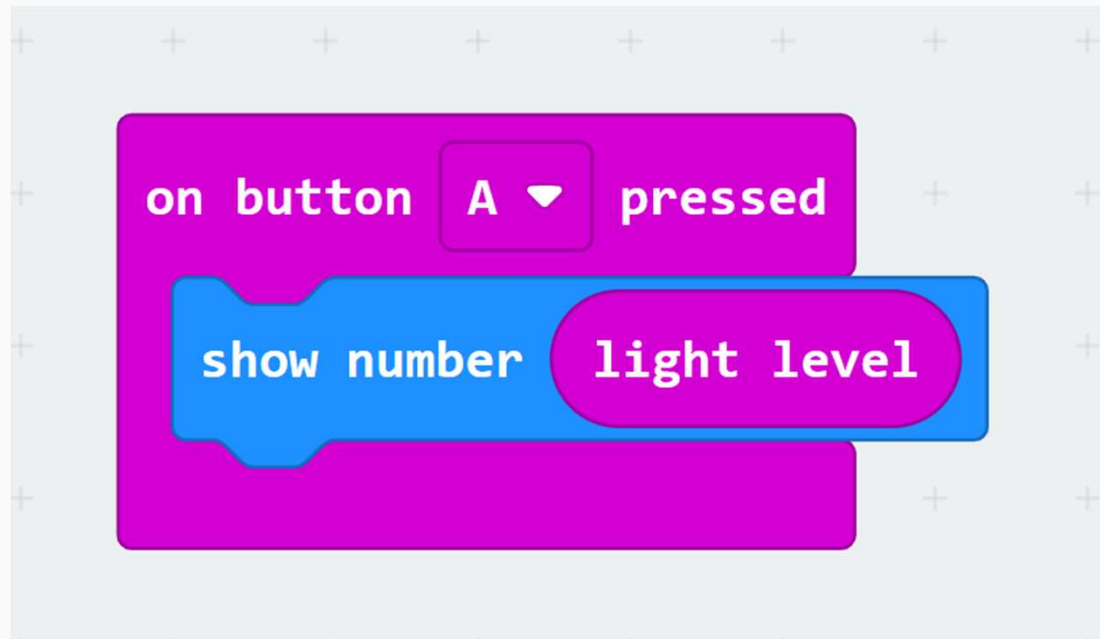

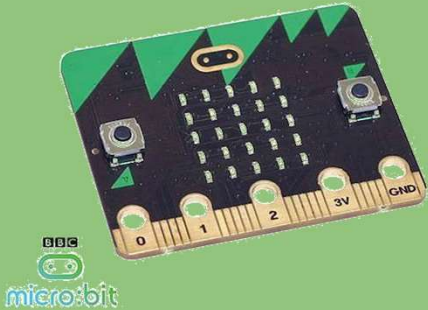

Compass Sensor

on button pressed

show number

compass heading (°)

Task: Once downloaded you must first rotate the Microbit until you fill the screen to calibrate the compass.

Part 2

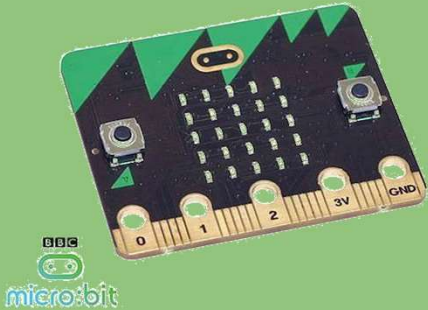

Changing Faces

```
on button A pressed
  repeat 4 times
    do
      show icon [5x5 grid icon]
      pause (ms) 200
      clear screen
      pause (ms) 200
```

```
on button B pressed
  repeat 4 times
    do
      show icon [5x5 grid icon]
      pause (ms) 200
      clear screen
      pause (ms) 200
```

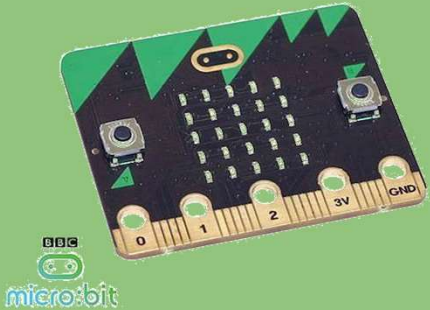

Step Counter

```
on start
  set steps to 0
```

```
on shake
  change steps by 1
  show number steps
```

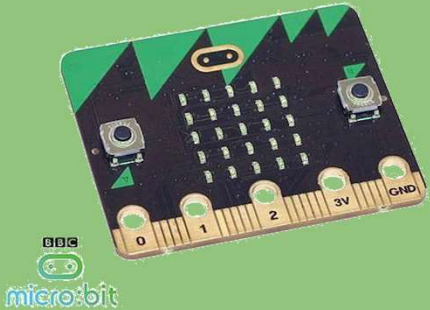

Different Sounds

```
on button A pressed
  show icon [happy face icon]
  play sound happy until done
```

```
on button B pressed
  show icon [sad face icon]
  play sound sad until done
```

```
on logo pressed
  show icon [happy face icon]
  play sound spring until done
```

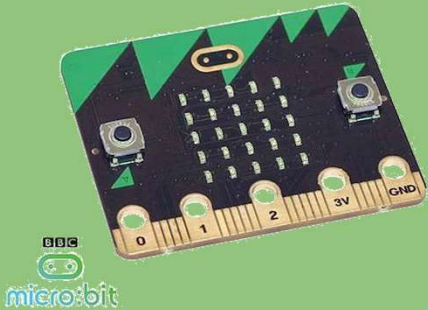

Clap Sounds

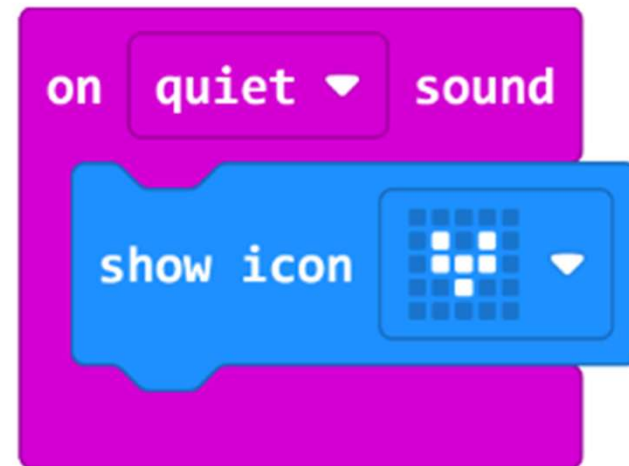
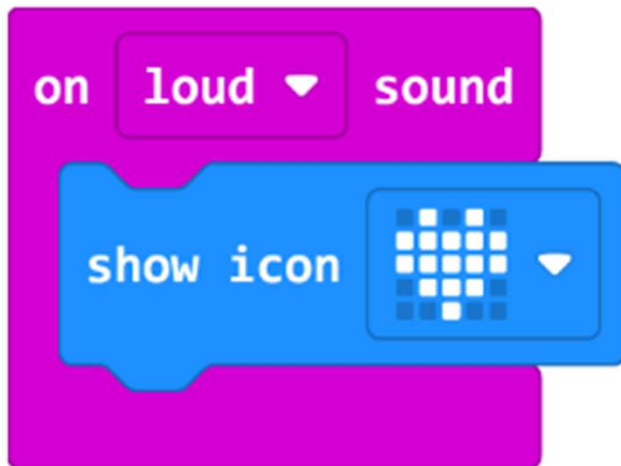

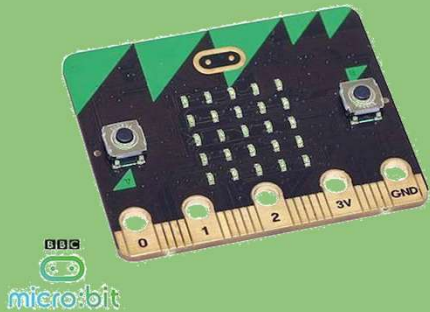

Sunlight Sensor

```
forever
  if light level > 100 then
    show leds
  else
    clear screen
```

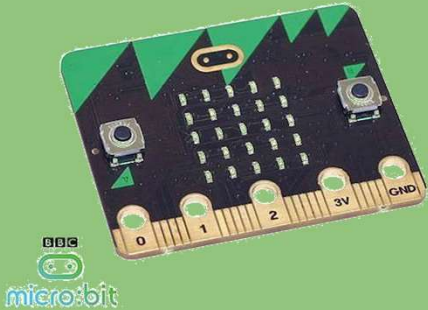

Rock, Paper, Scissors

```
on shake
  set tool to pick random 0 to 2
  if tool = 0 then
    show icon [Rock icon]
  else if tool = 1 then
    show icon [Paper icon]
  else
    show icon [Scissors icon]
```

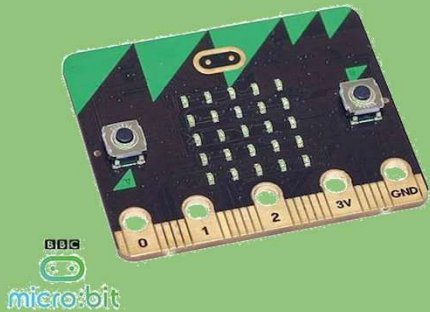

Clap Lights

```
on loud sound
  set lightsOn to not lightsOn
  if lightsOn then
    show leds
  else
    clear screen
```

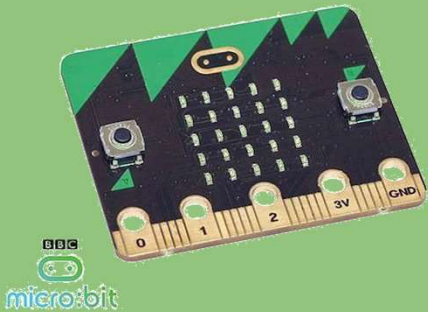

Compass Part 2

```
forever
  set degrees to (compass heading (°))
  if (degrees < 45 or degrees > 315)
  then show string " N "
  else if (degrees < 135)
  then show string " E "
  else if (degrees < 225)
  then show string " S "
  else show string " W "
```



NICIS
NATIONAL INTEGRATED
CYBERINFRASTRUCTURE SYSTEM

CHPC

THANK YOU

AN INITIATIVE OF



MANAGED BY

